

# How to Install

# @ BEKAERT

## High Tensile Fencing

(800)241-4126 x2272

[www.bekaert.com/na](http://www.bekaert.com/na)

## Building a Bekaert High Tensile Fence

### SAFETY FIRST!

Wear protective gloves, boots, and clothing to prevent serious lacerations when handling fencing components.

Protective eyewear is required! Sharp edges of fencing and components can cause serious eye injury.

Coiled fencing is under tension. Stay clear of fencing when releasing strapping from coils to prevent being struck and injured.

Local building code requirements should be consulted where applicable.

Carry staples in an apron or small bucket only!

Do one job at a time – don't rush!

Work with a partner to make the job safer and easier.

Always use a spinning jenny when unreeling high tensile smooth wire from coils.

Use a proper tensioning device to tighten fencing. (No tractors!)

Read and follow all directions from manufacturer!

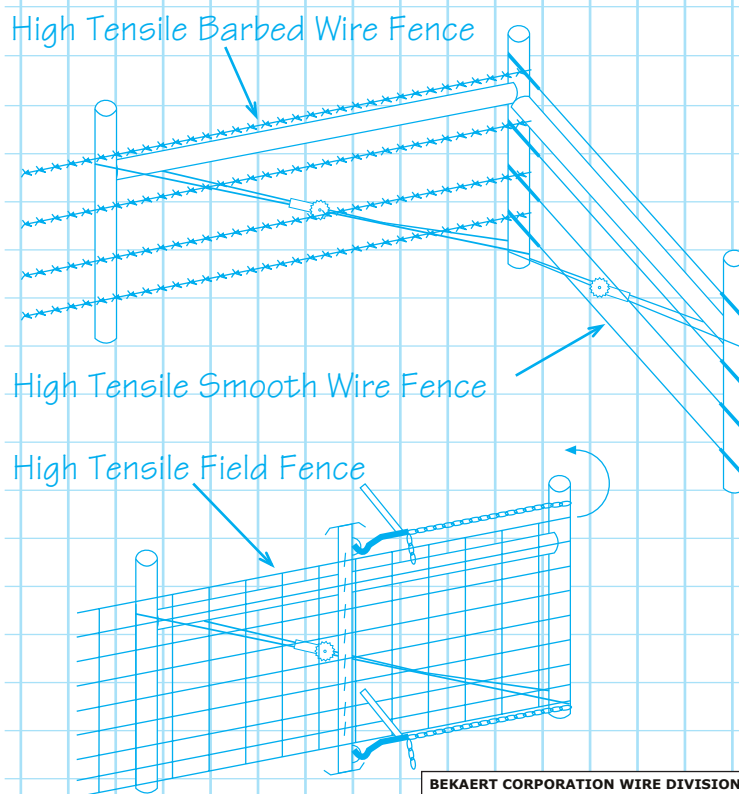

#### BEKAERT CORPORATION WIRE DIVISION

**WIRE DIAMETERS:**  
15<sup>1</sup>/<sub>2</sub>, 14, 12<sup>1</sup>/<sub>2</sub>, AND 10<sup>1</sup>/<sub>2</sub> GAUGE

**COATINGS:**  
CLASS 3 GALVANIZED,  
BEZINAL®+PAINT

**MEETS ASTM SPECIFICATIONS:**  
121 (15<sup>1</sup>/<sub>2</sub> GAUGE HIGH TENSILE BARBED WIRE)  
116 (HIGH TENSILE FIELD FENCE)

**COMMENTS:**  
HIGH TENSILE FENCING OFFERS GREATER STRENGTH  
AND LOWER WEIGHT THAN CONVENTIONAL FENCING.  
WITH PROPER INSTALLATION THIS FENCING WILL  
REQUIRE VERY LITTLE MAINTENANCE, AND HAVE A VERY  
LONG LIFE EXPECTANCY.

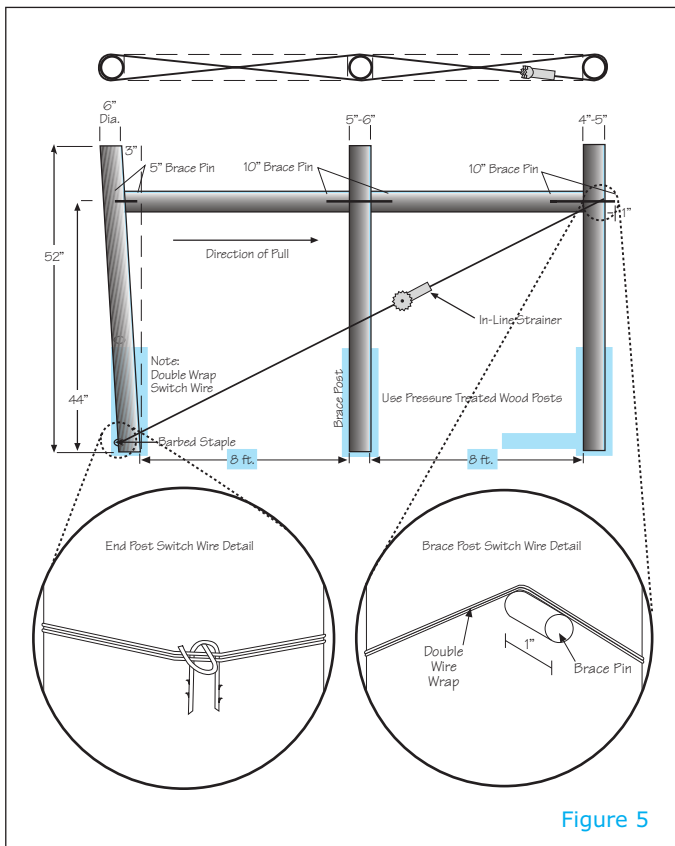

Figure 5

## How to Build a Double "H" Brace (Figure 5)

### Components

- Corner/end post: minimum 8' x 6" .40 CCA treated pine
- Middle brace post: 8' x 5"-6" .40 CCA treated pine
- Brace post: 8' x 4"-5" .40 CCA treated pine
- 2 - Cross member posts: 8' x 4" .40 CCA treated pine
- 2 - Optional cross members: 8' x 2" SS-20 H.T. tubing
- 12½ gauge high tensile wire
- In-line strainer
- 5" brace pin
- 2-10" brace pins
- Barbed staples
- Crimp sleeves

### Tools

- In-line strainer ratchet handle
- Drill
- Hammer
- Spinning Jenny
- Wire Cutter
- Crimping tool
- Tensioning Device (chain grab)

1. Position the brace by sighting down your newly created fence line. Brace posts should be set 48 inches into the ground. Drive the small end of the post into the ground, or if holes were dug,

cement posts in place. To handset a corner, end, or gate post using cement; you should first hammer a ring of staples half way into the wood near the base of the post. Dig your hole with an inverse bell shape at the base of the hole. Make sure the hole is at least 48 inches deep. Place the post in the hole with the stapled end down. Tamp about eight inches of dry sackrete mix tightly around the bottom. Continue alternating six inch layers of soil and sackrete mix to ground level, finishing with soil. The soil moisture will set up the sackrete mix. It is very important to finish with soil at ground level so water around the post will have a way to dissipate. Set corner/end posts on a 2 to 3 inch lean away from the direction of pull.

2. Drill brace pin holes at a height of 44 inches from ground level, or where the top rail will be between the top two wires. Next, drill the hole in the corner/end post approximately 2 to 3 inches deep. Finally, drill a hole all the way through the inner brace post and the center brace post.

3. Drill holes approximately 2 to 3 inches deep at each end of both cross members.

4. Insert a five inch brace pin into the hole that was previously drilled into the corner/end post. You should have 2 to 3 inches of the pin left sticking out of the post. Install one side of the first cross member by sliding the hole in the end over the pin that was left protruding from the corner/end post. Next, slide the first cross member into place. Use a hammer to drive a 10 inch brace pin through the hole in the middle brace post, and into the hole in the cross member. Make sure to leave at least three inches of the brace pin sticking out of the middle brace post. Use this protruding brace pin to install the second cross member. Hammer the second 10 inch brace pin through the inner brace post, and into the second cross member. Remember to leave one inch of the brace pin protruding from the inner brace post. (Figure 5)

5. Drive a barbed staple at a downward angle approximately four inches from the ground in the corner/end post. Hang another staple on one leg of this staple to prevent the wire from digging into the post. (Figure 5)

6. Wrap the brace wire two times in a double figure 8 pattern around all three posts. (Figure 5)

7. Use an in-line strainer, or a chain grab to tension the brace wire. If an in-line strainer is used: splice one end of the wire to the strainer with a crimp sleeve, and put the other end into the ratchet. Use only a ratchet handle designed for the product you are using to tighten the strainer! If using a chain grab or other tensioning device: Tension the wire; once the wire is tensioned splice the ends together with one long crimp sleeve or three short sleeves.

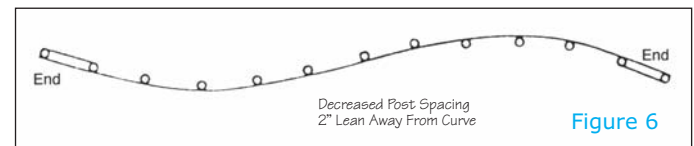

Figure 6

## Setting The Fence Line

Line posts are generally smaller than brace posts and should measure between 3½ – 4½ inches in diameter and 6½ to 8 feet in length.

Set line posts at a depth that allows approximately 52 inches of working height above the ground.

In applications for heavy grazing maximum post spacing is 30 feet on center with the use of fence stays. Fence stays should be spaced evenly in between line posts. Post spacing should be less if no stays are used.

Mark a spacer stick at the intervals you have chosen for your fence line wires. Use this stick to transfer the correct wire spacing marks to each line post in your system beginning with the bottom wire.

### Lay Of The Land

If your fence must curve, reduce post spacing in the curve area. Keep fence wire on the outside of the curve. The spacing change required will be determined by the severity of the curve. The sharper the turn the more posts it will require. A very gradual curve will not require post spacing to be greatly reduced. Set posts on curves with a two inch lean to the outside of the curve. (Figure 6)

If you must cross a depressed area, set a taller post at the bottom of the depression and brace it down as shown. (Figure 7) If water often runs through the depression, make the fence conform to the land with a buried dead weight. (Figure 8)

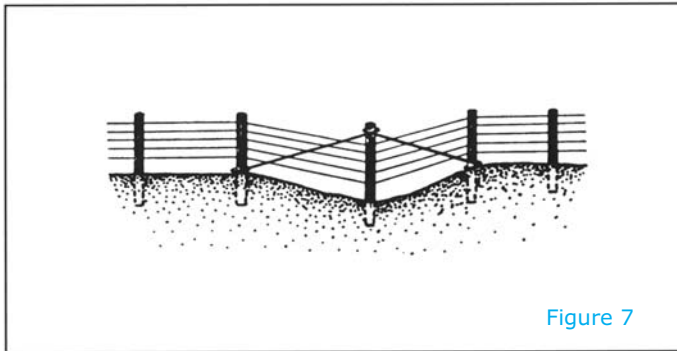

Figure 7

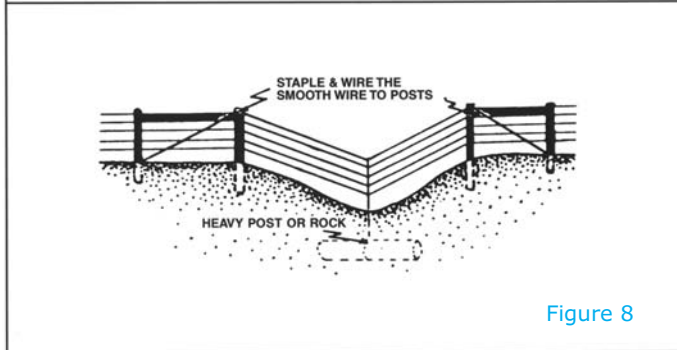
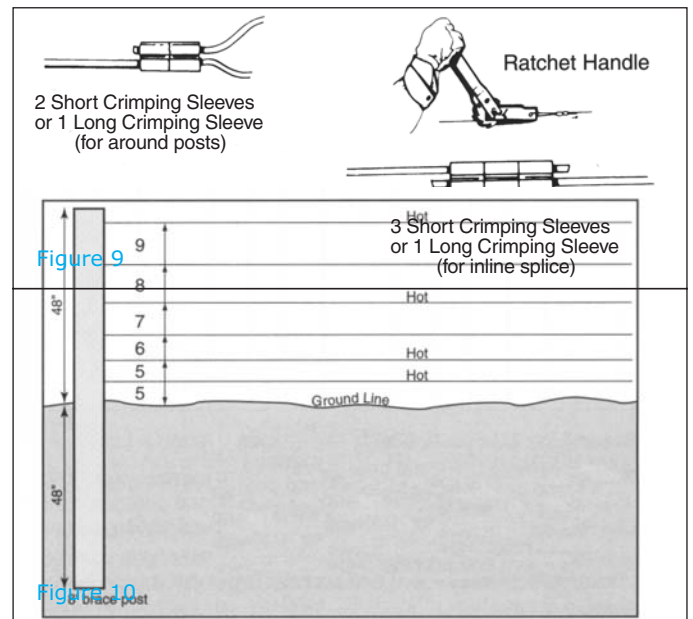

Figure 8

### Assembling The Bekaert Smooth Wire Fence

1. Work one strand at a time.
2. If using four inch fin tube insulators in an electric application: count all posts, then subtract corner, end, and gate posts that will use wraparound insulators. Add extra insulators to insulate the line wires from the brace wire. Pull out a small amount of wire to add insulators. Put all fin tubes and wrap-around insulators on wire before pulling the wire all the way out.
3. Position spinning jenny past the end post. Pull one strand the



length of the fence to the next brace post. (Figure 10) Put a crimp sleeve on the wire (don't compress yet) then slide the wire through the wrap-around insulator. Wrap the insulated wire around the end post and compress the crimp sleeve. (Figure 9) Staple the wrap-around insulator to the end post.

4. Distribute insulators to each post. Start at the end of the fence that is already spliced in place. Staple the insulators to the posts at the appropriate marks. Be sure that you don't staple the insulators too tightly; the wire should be able to slide.

5. After the insulators are all stapled in place, put a crimp sleeve on the wire at the opposite end, then put on a wrap around insulator. Wrap the insulated wire around the post, compress the crimp sleeve, and staple the wrap-around to the post. Make sure you leave at least 12 inches of slack in the wire for an in-line strainer.

6. Repeat this process for all wires in the fence.

7. When all strands are attached, install an in-line strainer for each strand of wire. You will need at least one strainer for every wire in each section you pull. You can have a maximum of 4000 feet between strainers. Reduce pull by 500 feet for each corner. Also reduce distance pulled if working over rough terrain.

8. Install a tension spring with one of the in-line strainers per section. This will help you gauge the wire tension. If the tension spring is nine inches; proper tension of 250 pounds has been reached when the spring is compressed to seven inches. If your tension spring has two notches; the first notch indicates 150 pounds and the second notch indicates 250 pounds of tension. (Figure 10)

9. To increase the overall strength of your fence you can install fence stays every 10 feet between posts. Plastic stays can be used in all applications. For non-electric applications any type of stay can be used. Steel stays can be used in electric applications if all wires are hot.

## Fence Materials Checklist

This worksheet will help you quickly estimate the amount of material, and the approximate costs involved in building your new fence. Complete this form and take it to your local Bekaert dealer, and they will help you place your order right from this worksheet.

### Smooth Wire

\_\_\_\_\_ Length of fence in feet (5,280' = 1 mile)  
x \_\_\_\_\_ Number of strands  
= \_\_\_\_\_ Total wire length needed (length of fence x number of strands)  
/ 4000 Divide by 4,000'  
= \_\_\_\_\_ Number of Bekaert 12 1/2 gauge high tensile coils needed

### Barbed Wire

\_\_\_\_\_ Length of fence in feet (5,280' = 1 mile)  
x \_\_\_\_\_ Number of strands  
= \_\_\_\_\_ Total wire length needed (length of fence x number of strands)  
/ 1320 Divide by 1,320'  
= \_\_\_\_\_ Number of Bekaert high tensile barbed wire reels needed

### Field Fence

\_\_\_\_\_ Length of fence in feet (5,280' = 1 mile)  
/ 330 Divide by 330'  
= \_\_\_\_\_ Number of Bekaert high tensile field fence rolls needed

### Brace Wire

**You will need enough smooth wire to complete all braces in your fence.**

### Posts

\_\_\_\_\_ Length of line post (height of fence + depth of hole)  
\_\_\_\_\_ Number of wood line posts @ 30' max spacing (use the distance between brace posts for a given stretch, divide by post spacing, and then subtract 1)  
\_\_\_\_\_ Length of corner/brace post (height of fence + depth of hole)  
\_\_\_\_\_ Number of single corner and end brace posts (3 posts per corner, 2 for end)  
\_\_\_\_\_ Number of double corner and end braces posts (5 posts per corner, 3 for end)  
\_\_\_\_\_ Length of cross post (height of fence multiplied by 2.5, round to the nearest foot)  
\_\_\_\_\_ Number of cross member posts (2 for single corner, 1 for single end, 4 for double corner, and 2 for double end)

### Fence Hardware

\_\_\_\_\_ Number of fence stays/spacers (every 10' between posts)  
\_\_\_\_\_ Fence stay length (distance between top and bottom wire)  
\_\_\_\_\_ Staples (Multiply the number of posts by number of wires. Then divide by 52 to convert into pounds. Staples are sold in 8 and 50 pound buckets.)  
\_\_\_\_\_ Crimp sleeves  
\_\_\_\_\_ In-line strainers  
\_\_\_\_\_ Tension springs  
\_\_\_\_\_ Line wire insulators (Number of line posts, multiplied by number of wires, plus extra to insulate brace wires)  
\_\_\_\_\_ Wrap-around insulators (1 for each corner, end, and gate post per wire)

### Tools

\_\_\_\_\_ Drill  
\_\_\_\_\_ Pliers  
\_\_\_\_\_ Hammer  
\_\_\_\_\_ Wire Cutter  
\_\_\_\_\_ Post Driver / Post Hole Digger  
\_\_\_\_\_ Spinning Jenny  
\_\_\_\_\_ Crimping Tool  
\_\_\_\_\_ String  
\_\_\_\_\_ Flag Sticks  
\_\_\_\_\_ In-Line Strainer Ratchet Handle  
\_\_\_\_\_ Tensioning Device (chain-grab, come-along)

### Safety Gear

\_\_\_\_\_ Eye Protection  
\_\_\_\_\_ Leather Gloves  
\_\_\_\_\_ Protective Clothing  
\_\_\_\_\_ Safety Toe Boots

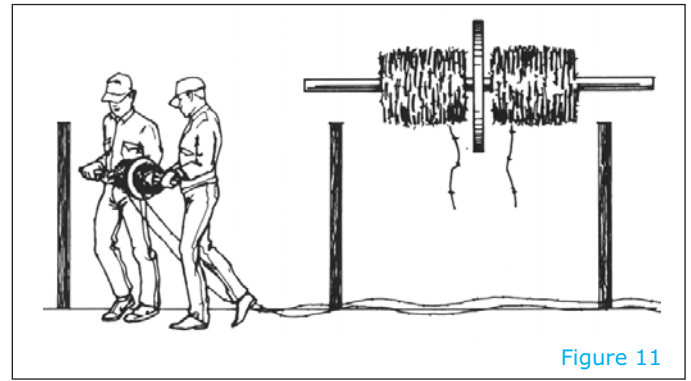

Figure 11



Figure 12

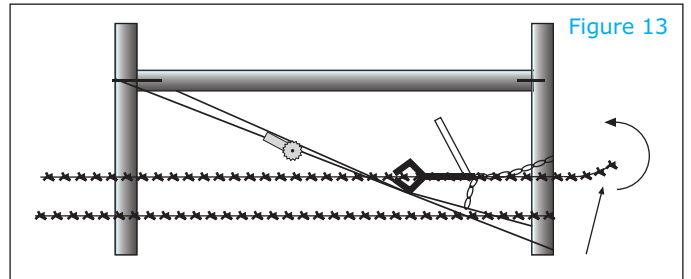

Figure 13

## Assembling The Bekaert High Tensile Barbed Wire Fence

1. Fasten one strand at a time to the anchor post at the appropriate height. Start with the bottom wire. Wrap the strand around the post one time, and then splice it back on itself. Wrap the wire around itself at least five times. Staple.
2. Unroll no more than two strands at a time. Pay out wire on the side you want your fence. Work one span at a time between braces. Unroll the reels as pictured in (Figure 11) with the wire being paid out from the bottom.
3. If you start with less than a full reel and run out, carefully splice a new strand onto the old by wrapping each end onto the other. Wrap each end 5-8 times. (Figure 12) Commercial crimp sleeves are available and work great for this application.
4. After you have unrolled enough wire to complete the span, walk the fence line to check for obstructions. After you have cleared all obstructions you can tension the fence wire. You can tension high tensile barbed wire using a chain grab or a come-along.
5. Use a chain grab or come-along to tension Bekaert high tensile barbed wire. First, attach the device to the wire and the end post. Make sure you do not attach where your wire has to go. Next, tension the wire. After the proper tension has been reached take the free end of the wire and pull it hand tight. Wrap this end around the end post one time. Finally tie off this wire by wrapping it around itself at least five times. Carefully release the tensioning device. (Figure 13)

6. When each strand has been attached and tensioned you can begin stapling the strands to the posts. Begin stapling at the middle of the fence line and work your way to the ends. (If working over hilly ground: staple the high points first, dips second, and then the rest of the fence.) (Figure 18)

7. You can increase the overall strength of your fence by using fence stays at 10 foot intervals over the length of the fence.

Figure 14

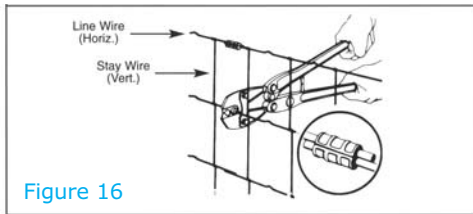
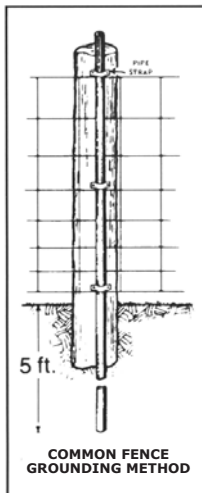
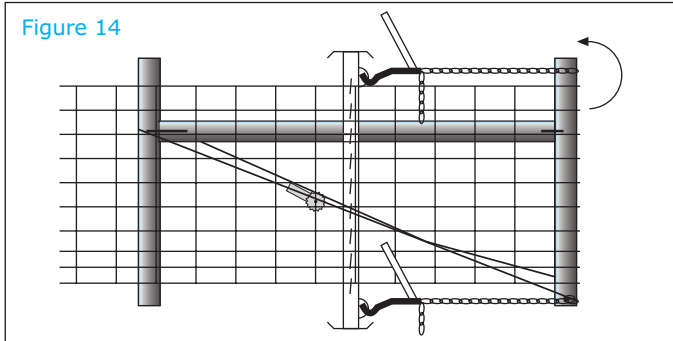
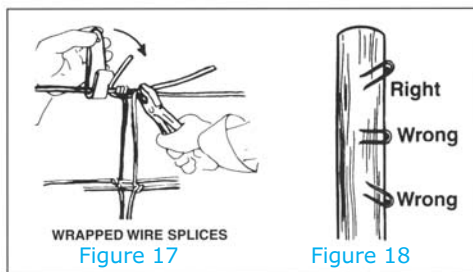

Figure 16



## Assembling a Bekaert High Tensile Field Fence

Field fence rolls are larger and heavier than smooth wire coils, and barbed wire reels. You should spend the time necessary to clear a fence line that is wide enough to unroll field fence.

1. Unroll the fence along the side of the posts you want it to be placed with the bottom nearest the posts. The smaller openings are the bottom of the fence. Leave approximately 2-3 extra feet of fencing at the end post. After you roll out approximately 25 feet stop and attach to the end post.

2. Strip the first two vertical stay wires so that you have at least 12 inches of line wire free. Place the last vertical stay wire against the end post. Next take one of the middle line wires and wrap it around the end post. Tie it off by wrapping it onto itself at least five times. Use this method of attachment for all line wires. After all of the wires have been wrapped and tied, you can use a few staples to hold the fence at the proper height.

3. Slowly unroll the fence to the next brace.

4. Splice new rolls in as needed. Commercial crimp sleeves are well worth their cost in this application. (Figure 16)

5. If crimp sleeves are not used, leave six inches of line wire beyond the last vertical stay wire for each roll. Match the vertical stay wires and wrap the free line wires from each fence onto the opposite fence. (Figure 17)

6. After enough fence has been rolled out to reach the next brace, go back to check the fence line. Make sure the fence is free from obstructions, and will not get stuck on anything while tensioning.

7. Attach your stretcher bar to the fence near the middle of the brace. Make sure you can reach the end post with your tensioning device. When the stretcher bar is securely attached to the fence, hook two tensioning devices into its loops. Attach the tensioning device to end post and slowly tension the fence. (Figure 14) It is a good idea to stop and recheck the fence line for obstructions after you have started tensioning the fence. Finish tensioning the fence.

8. After the fence is properly tensioned cut the end approximately 2-3 feet past the end post. Strip at least two vertical stays then wrap and tie the line wires using the same method as the opposite end post. Make sure to pull the free end of the fence as tight as possible by hand before tying off. After all wires are tied off, slowly release the tensioning device. Finally remove the stretcher bar from the fence.

9. When the fence is tight and the stretcher bar has been removed you can begin stapling. Start at the middle of the fence line and staple at least every other line wire to the posts. Leave the staples loose enough to allow the fence to move. (If working over hilly ground: staple the high points first, dips second, and then the rest of the fence.) (Figure 18)

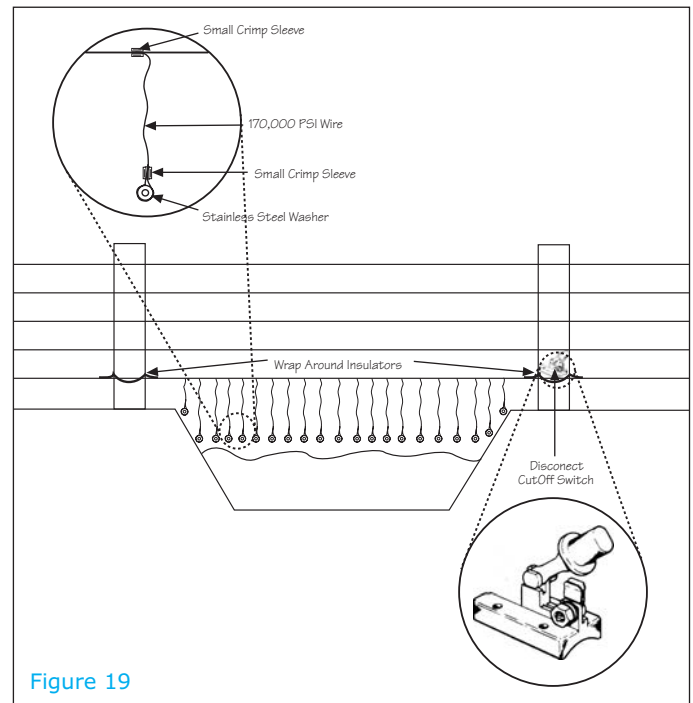

Figure 19

## Crossing Waterways

### Build Your Floodgate To Be Flexible

If your fence crosses a gully that occasionally floods, a creek, or an irrigation ditch, it's best to build a floodgate extending from

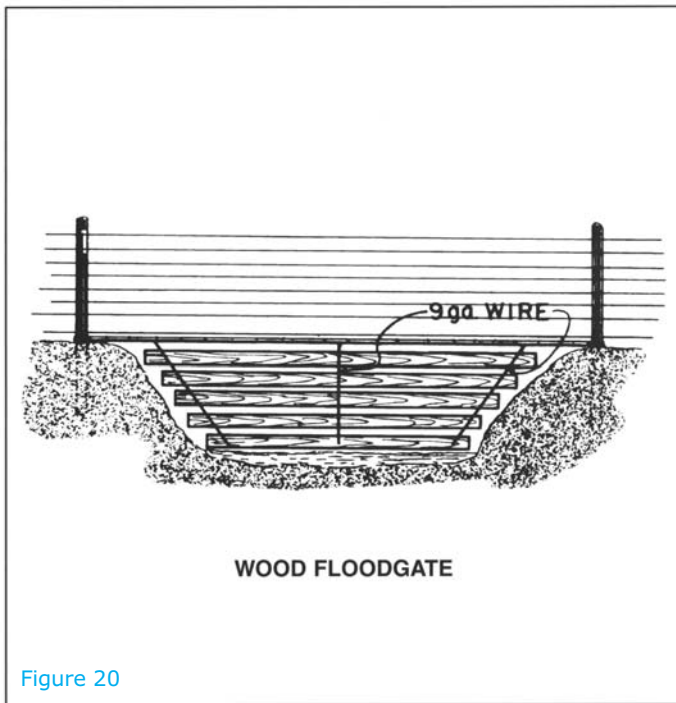

Figure 20

the bottom line wire to a depth equal to the water level or the lowest point of the ditch.

A practical option for water crossings with electric fences, is to attach wires hanging vertically from your bottom fence wire. You can use the same high tensile wire that was used in the rest of the fence. Some people like to use stainless steel washers as weights attached at the bottom of these wires. The vertical wires should be spaced 6-10 inches apart and cover the area over the ditch or stream. Make sure the wires don't touch the ground or water. If you use this option you should insulate the bottom wire crossing the stream from the rest of your fence by using wrap-around insulators. You can then add a cut-out switch so this water crossing can be shut off if the water rises. (Figure 19)

A non-electric option for stream crossings less than 20' is a panel made from pressure treated 1" x 4" boards. First, attach a stranded cable beneath your fence, attach it to the second post back on each side of the ditch and pull tight. Next, cut the boards to approximate the contour of the ditch, and then fasten the boards into a single panel with class three, 9 gauge merchant wire, stapling the wire to each board, leaving 4-6 inches between boards. Loop the merchant wire at the top to form a hinge, allowing the panel to swing on the stranded support cable. (Figure 20)

## 9 Common Fencing Configurations

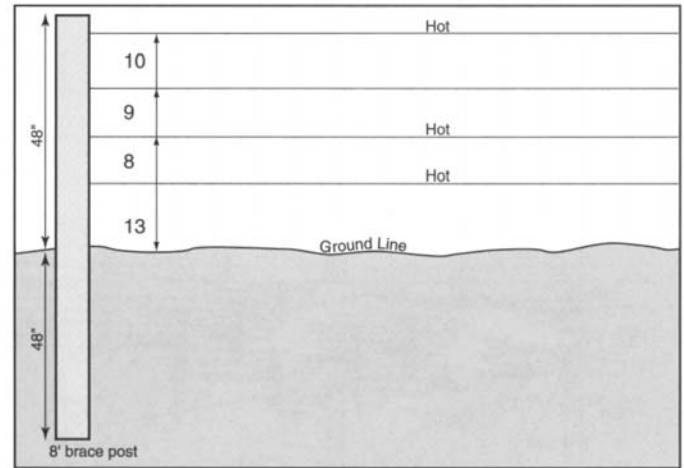

Figure 21 Four Wire Cross Fencing

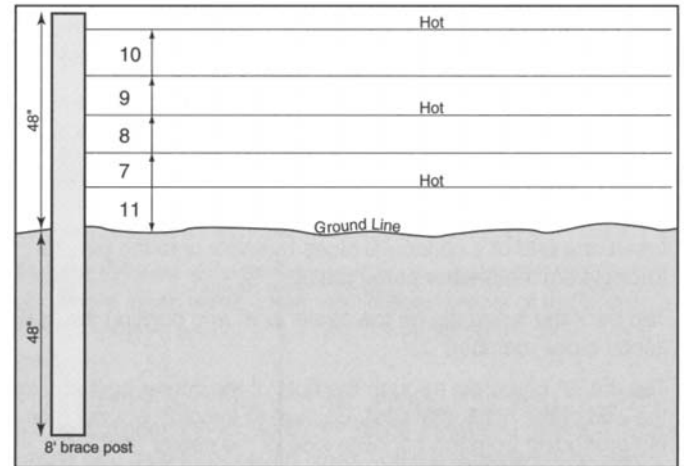

Figure 22 Five Wire Fence for Cattle

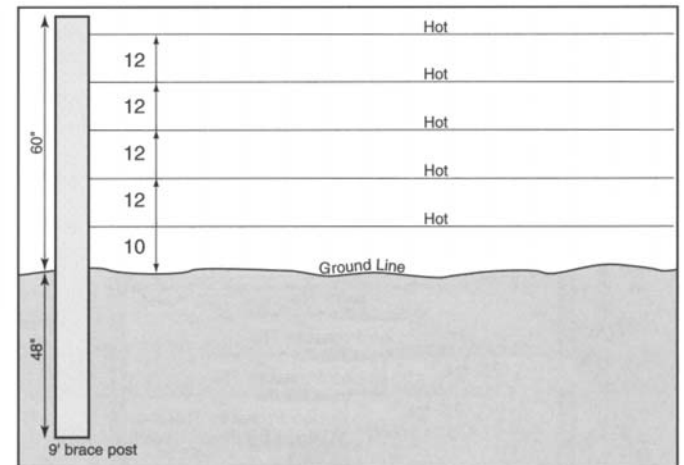

Figure 23 Five Wire Anti-Deer Fence, Penn State Design

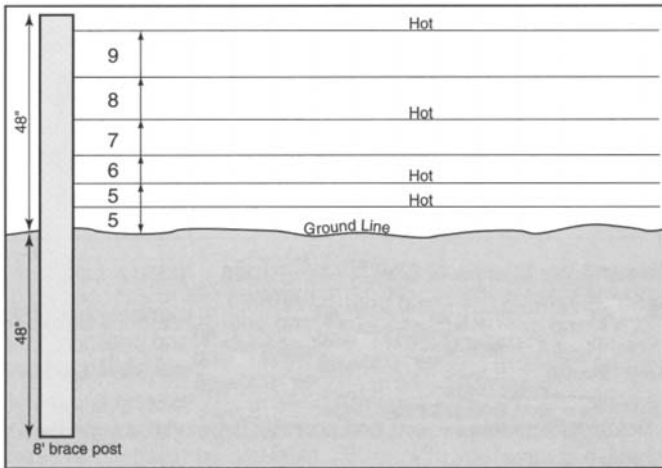

Figure 24 Six Wire Fence for Sheep & Hogs

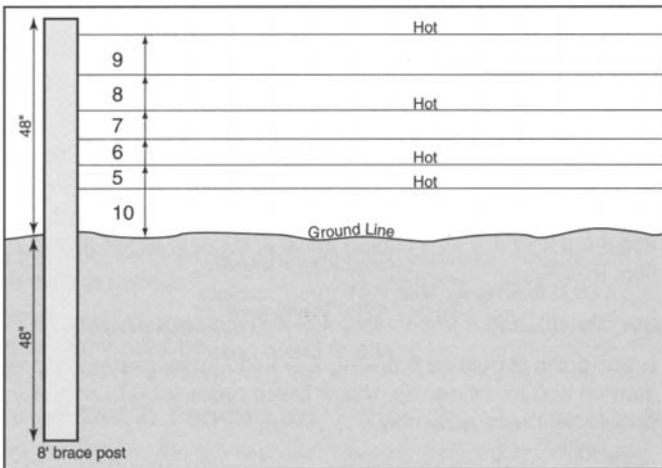

Figure 25 Six Wire Fence for Cattle

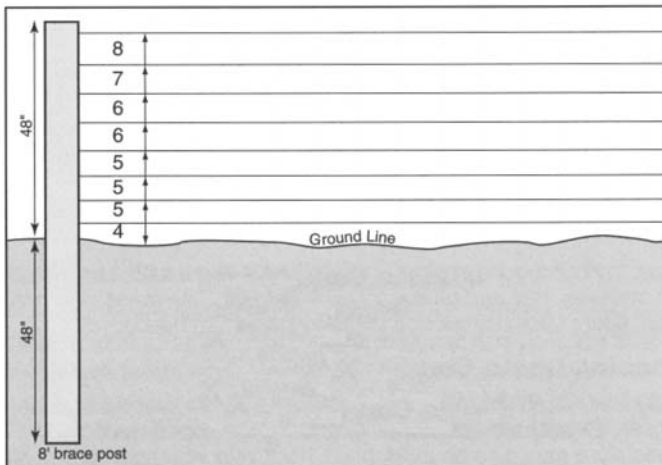

Figure 26 Eight Wire Fence for Cattle, Sheep & Goats  
Always use your fence charger manufacturer's instructions.

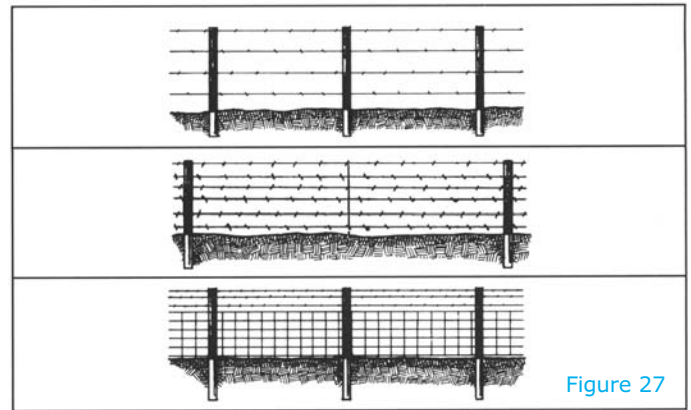

Figure 27

### Common Barbed Wire & Field Fence Configurations

## Why Bekaert High Tensile Fencing is the Best Choice!

1. Bekaert high tensile fencing is lighter and stronger than conventional fence wire.
2. Bekaert high tensile fencing with class three coating has more than double the galvanization of ordinary fencing to last much longer.
3. Bekaert high tensile fencing is easier to install. Its lighter weight makes it easier to handle.
4. Bekaert high tensile fencing requires very little maintenance.
5. Bekaert high tensile fence is available with a traditional class three galvanized coating, or an aesthetically pleasing Bezinal® + Paint coating.

## Building Corner and End Braces

### When to Build Single or Double "H" Braces

- Single "H" braces are used for fences that consist of six or fewer high tensile smooth or barbed wires. Up to 330' of field fence.
- Double "H" braces are used for fences that consist of more than six high tensile smooth or barbed wires. Up to 660' of field fence.

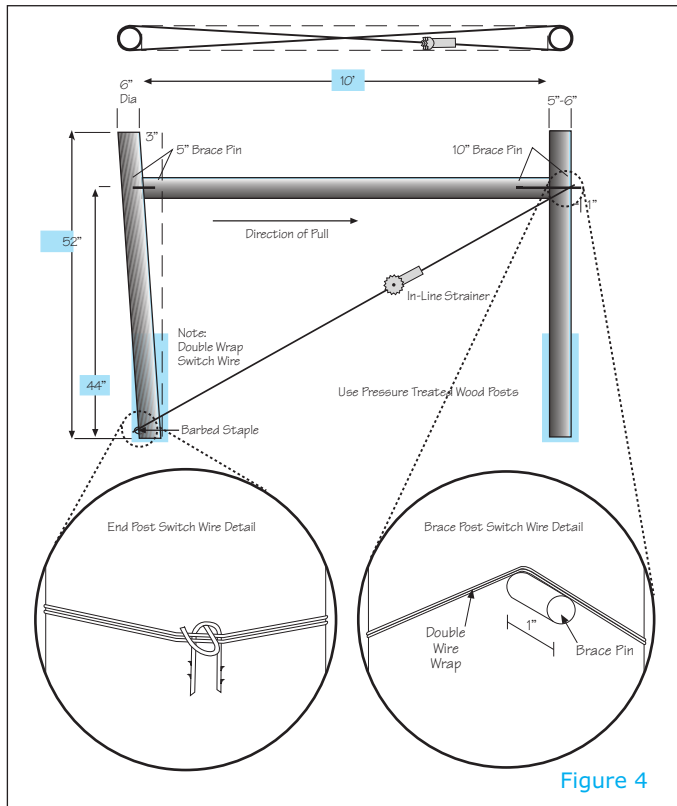

Figure 4

### How to Build a Single "H" Brace (Figure 4)

#### Components

- Corner/end post: minimum 8' x 6" .40 CCA treated pine
- Brace post: 8' x 5"-6" .40 CCA treated pine
- Cross member: 10' x 4" .40 CCA treated pine
- Optional cross member: 10' x 2" SS-20 H.T. tubing
- 12½ gauge high tensile wire
- In-line strainer
- 5" brace pin
- 10" brace pin
- Barbed staples
- Crimp sleeves

#### Tools

- In-line strainer ratchet handle
- Drill
- Hammer
- Spinning Jenny

- Wire cutter
- Crimping tool
- Tensioning Device (chain grab)

1. Position the brace by sighting down your newly created fence line. Brace posts should be set 48 inches into the ground. Drive the small end of the post into the ground, or if holes were dug, cement posts in place. To handset a corner, end, or gate post using cement; you should first hammer a ring of staples half way into the wood near the base of the post. Dig your hole with an inverse bell shape at the base of the hole. Make sure the hole is at least 48 inches deep. Place the post in the hole with the stapled end down. Tamp about eight inches of dry sackrete mix tightly around the bottom. Continue alternating six inch layers of soil and sackrete mix to ground level, finishing with soil. The soil moisture will set up the sackrete mix. It is very important to finish with soil at ground level so water around the post will have a way to dissipate. Set corner/end posts on a 2 to 3 inch lean away from the direction of pull.

2. Drill brace pin holes at a height of approximately 44 inches from ground level, or where the top rail will be between the top two wires. Next, drill a hole in the corner/end post approximately 2 to 3 inches deep. Finally, drill a hole all the way through the inner brace post.

3. Drill holes approximately 2 to 3 inches deep at each end of the cross member.

4. Insert a five inch brace pin into the hole that was previously drilled into the corner/end post. You should have 2 to 3 inches of the pin left sticking out of the post. Install one side of the cross member by sliding the hole in the end over the pin that was left protruding from the corner/end post. Next, slide the cross member into place. Use a hammer to drive the 10 inch brace pin through the hole in the brace post, and into the hole in the cross member. Make sure to leave one inch of the brace pin protruding from of the brace post. (Figure 4)

5. Drive a barbed staple at a downward angle approximately four inches from the ground in the corner/end post. Hang another staple on one leg of this staple to prevent the wire from digging into the post. (Figure 4)

6. Wrap the brace wire two times in a figure 8 pattern around the posts making sure to go over the top of the protruding brace pin, and below the staple at the bottom of the corner/end post. (Figure 4)

7. Use an in-line strainer or a chain grab to tension the brace wire. If an in-line strainer is used: splice one end of the wire to the strainer with a crimp sleeve, and put the other end into the ratchet. Use only a ratchet handle designed for the product you are using to tighten the strainer! If using a chain grab or other tensioning device: Tension the wire; once the wire is properly tensioned, splice the ends together with one long crimp sleeve or three short crimp sleeves.

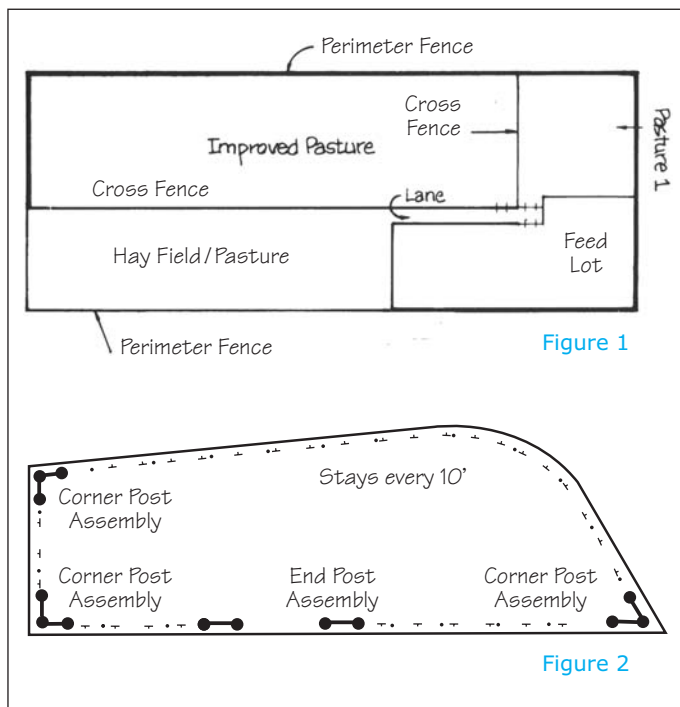

Figure 1

Figure 2

### Planning a Bekaert High Tensile Fence

Bekaert high tensile fence with class three coating lasts twice as long as a conventional class one coated fence. With this long life expectancy it makes sense to really plan your fencing project. Instead of simply replacing the current fence exactly as it was, think about how you would really like it to be set up. Consider the long term use of the land, and the changes you might want to make in the future.

Begin by sketching a map of your farm or ranch. A helpful planning tool is an aerial map of your property. They are easily obtained from the following sources:

- The U.S. Soil Conservation Service
- The U.S. Agriculture Stabilization and Conservation Service
- The Agricultural Extension Service
- An aerial survey firm listed in the telephone directory

Next, lay out a land use plan. (Figure 1) Make land assignments for pastures, hay, crop, and perhaps wildlife areas. From this plan, you can figure your current and anticipated fencing needs.

### Fencing Costs Can Be Shared

Neighbors often share in the cost of building or replacing boundary fences. Cost-share assistance from the U.S. Department of Agriculture may also be available. Check with your county's Agriculture Stabilization and Conservation Office.

### Make A Fence Plan

Sketch out your fence needs to the same scale as your land use plan. (Figure 2) You should be able to estimate how many linear feet your fence will be. For greater accuracy measure your planned fence line with a measuring wheel or string. Add up the total lengths minus gate openings.

### Selecting The Right Fence

For the most economical fence design, or combination of designs consider these questions:

- What kind of livestock, cattle, sheep, etc.
- How many head per pasture?
- How rough is the terrain?
- Is electricity accessible?
- Is water accessible?
- Where will my interior fences need to be?
- Will there be an issue with rocks or other tough ground conditions?

### Selecting the Right Type of Coating

Air humidity, blowing sand or dust, abrasive chemicals in the soil, air applied crop dusting fertilizer, salt, pollution, and acid rain can all drastically reduce fence life. Class one galvanizing is the normal protective coating used on standard fence wire. Bekaert uses a class three coating on high tensile fence wire. This coating is approximately two and a half times heavier than class one coating. This heavier coating provides longer lasting protection from the elements. Another great looking coating option is Bezinal® + Paint. This coating gives you an aesthetically pleasing color option and lasts even longer than class three galvanized.

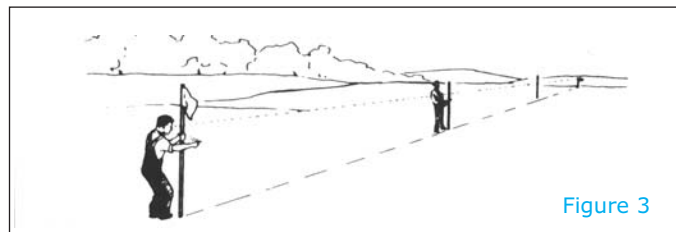

Figure 3

### Laying Out A Fence Line

Clear the planned fence line so you have an unobstructed work area. Set a flagged 6 foot stake at each end, and station another person at one of the stakes. Starting from the opposite end, set 4 foot stakes every 100 feet using the other person to verify correct placement. (Figure 3)

Another method to lay out a fence line is to use a smooth wire or string to establish the fence line. First, set both end posts for a section. Next, stretch a string or wire between the posts. Wrap the string or wire at least two times around each post before tying off. Make sure both posts have the wire on the same side, either inside or outside of the post. The string cannot be fastened at the center of either post. Finally, use another person to straighten the line using the two posts that are already set as a reference.